



NPL



## NPL Series

VALVE REGULATED LEAD-ACID BATTERIES

NPL

# NPL VALVE REGULATED LEAD-ACID BATTERIES (VRLA)

The NPL range is an enhanced NP design resulting in a longer service life (7 - 10yrs). All other attributes and operational characteristics are the same, thereby maintaining the benefit of a common mechanical and electrical design for users of both products.

## FEATURES

- Yuasa VRLA batteries can be used in any orientation excluding continuous use inverted.
- Standard case material is flame retardant to (UL94) HBØ.
- FR option case material is flame retardant to UL94:VØ (oxygen index 30).
- NPL batteries are manufactured in factories that comply with ISO 9001:2000.
- FR option NPLs comply with BS6290 Part 4 (1997).
- NPL batteries comply with IEC 60896-21+22.

## Layout

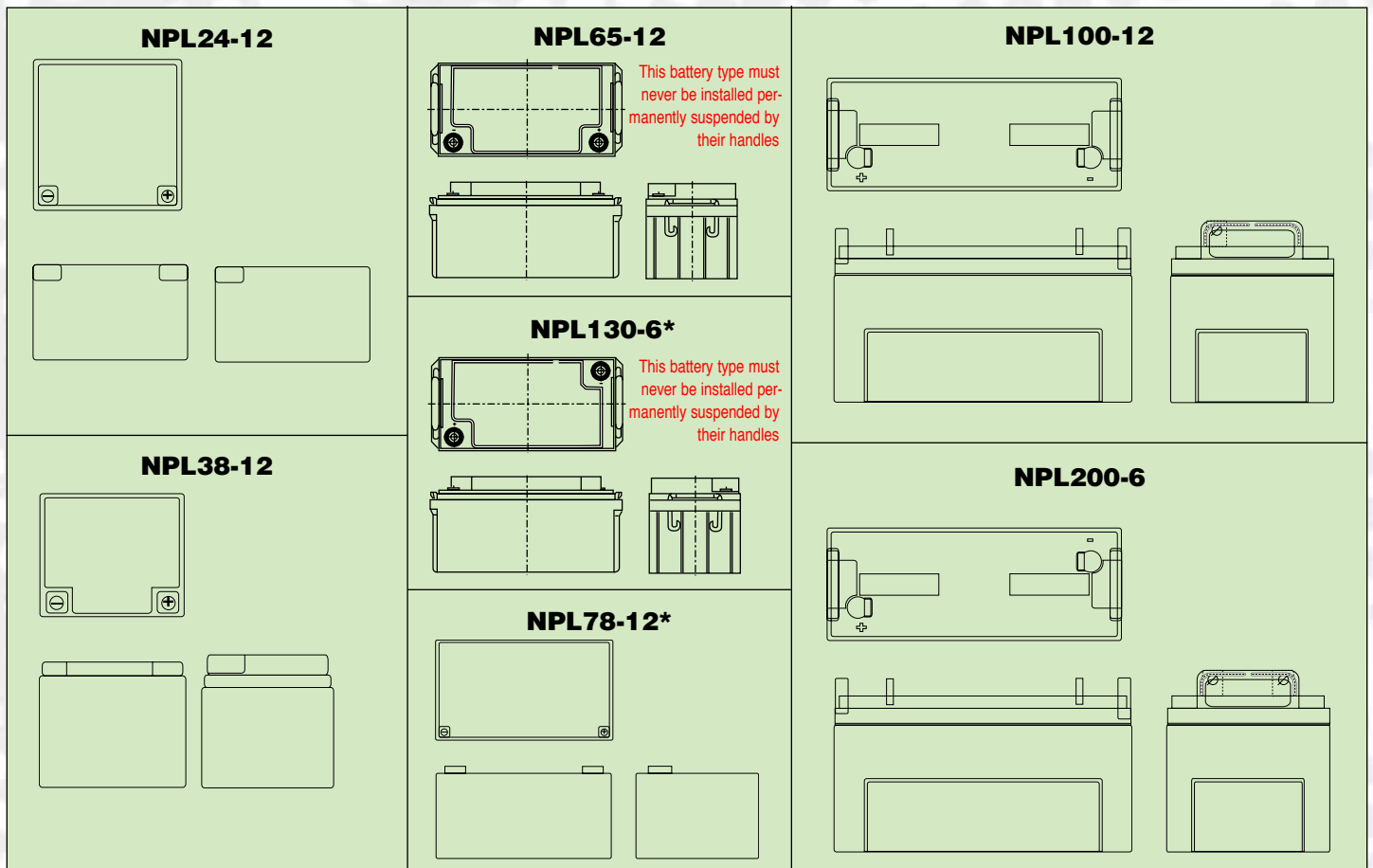

\*Models available in Flame Retardant case only.

## Terminals

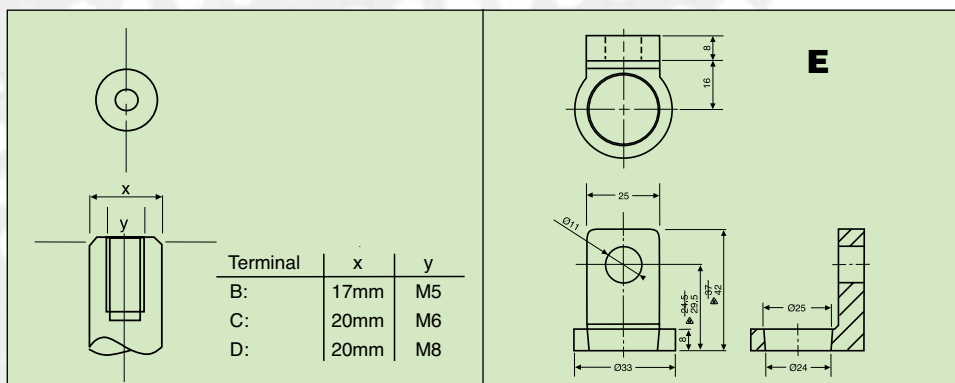

## General Specifications

Nominal Capacity (Ah)	NPL130-6IFR	NPL24-12I	NPL38-12I	NPL65-12I	NPL78-12IFR	NPL100-12	NPL200-6
20hr to 1.75vpc 20°C	130	24	38	65	78	100	200
10hr to 1.75vpc 20°C	120	22.3	35.3	60.5	72.6	93	186
5hr to 1.70vpc 20°C	110	20.4	32.3	55.3	66.3	84	168
1hr to 1.60vpc 20°C	78	14.4	22.8	39	46.8	60	120
Voltage	6	12	12	12	12	12	6
Energy Density (Wh/L)	77	79	83	77	85	75	71.64
Specific Energy (Wh. kg)	34	32	32	34	34	29	28.3
Int Resistance (m.ohms)	2.5	9.5	7.5	5	<5	4	1.3
Maximum discharge (A)	390	150	200	500	500	500	600
Short Circuit current	800	500	500	800	800	800	1500
<b>Dimensions (mm) +/- 2mm</b>							
Length	350	166	197	350	380	407	407
Width	166	175	165	166	166	172	172
Height overall	174	125	170	174	174	240	240
Weight	23	9	14.2	23	27.5	39	39
Terminal	C	B	B	C	D	E	E
Torque (Nm)	4.76	2.45	2.45	4.76	6.1	16.5	16.5

## Operational Temperature Range

Charge -15°C to 50°C

Discharge -20°C to 60°C

Storage -20°C to 50°C (fully charged condition)

## Applications

- Security and Fire
- UPS
- Telecoms
- Emergency Lighting

### CHARGING CHARACTERISTICS

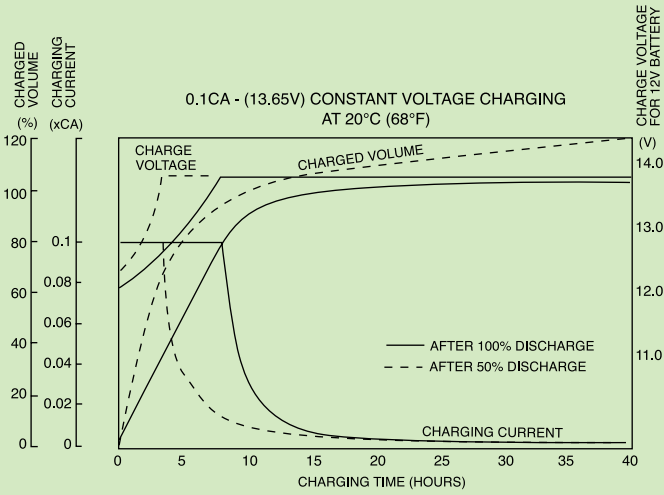

### CHARGING CHARACTERISTICS

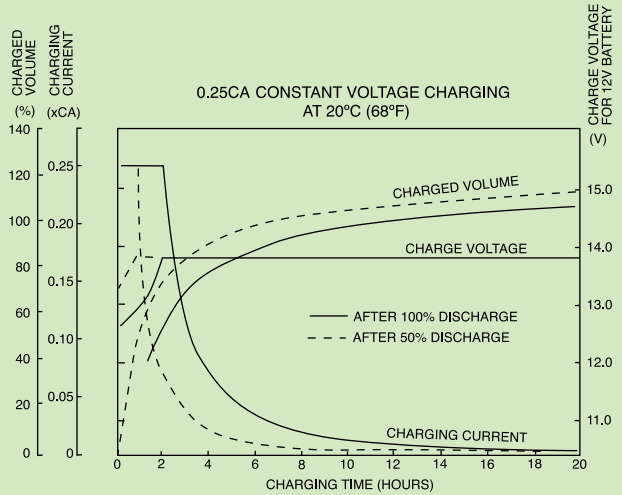

### DISCHARGE CHARACTERISTICS CURVES

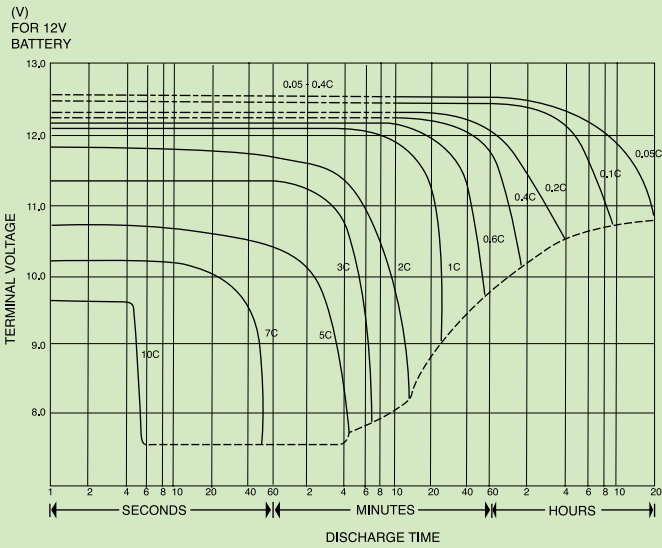

### TEMPERATURE/LIFE CHARACTERISTIC

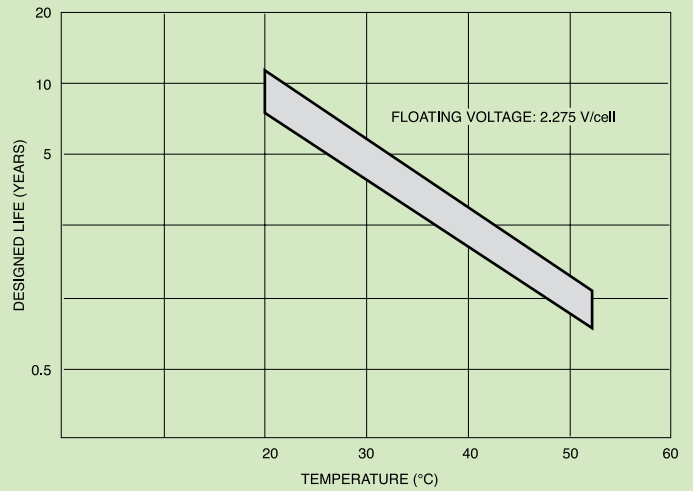

### SELF DISCHARGE CHARACTERISTICS

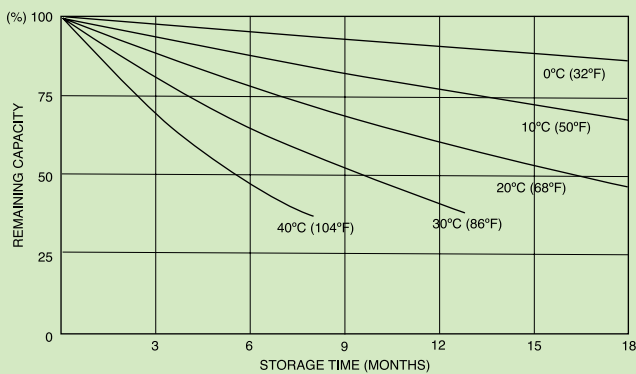

### Charging Methods (at 20°C)

**Standby use:** Float charging voltage 2.275vpc

### CAUTION

- Avoid short circuit.
- Do not charge in a sealed container.
- Service life and operational characteristics will be affected by temperature.
- AC Ripple reduces service life.



**Yuasa Battery Sales (UK) Ltd**

Unit 13, Hunts Rise, South Marston Park, Swindon SN3 4TG

Tel: 01793 833555 Fax: 01793 833579

Email: enquiries@yuasaeurope.com

Registered number 1548820

Cat. No. NPLSF January 2014

E&O.E.

Distributed by